

CAPILLARY DIAL THERMOMETERS TYPE TXC

TYPE	DRAWING	DIMENSIONS mm																																															
A TXCxxxXA		<table border="1" style="margin-left: auto; margin-right: auto;"> <thead> <tr> <th rowspan="2">DIM.</th> <th colspan="5">CASE DIAMETER</th> </tr> <tr> <th>63</th> <th>80</th> <th>100</th> <th>160</th> <th>250</th> </tr> </thead> <tbody> <tr> <td>A</td> <td>65</td> <td>83</td> <td>101</td> <td>161</td> <td>252</td> </tr> <tr> <td>B</td> <td>38</td> <td>37</td> <td>45</td> <td>45</td> <td>55</td> </tr> <tr> <td>C</td> <td>13</td> <td>13</td> <td>13</td> <td>13</td> <td>13</td> </tr> </tbody> </table>	DIM.	CASE DIAMETER					63	80	100	160	250	A	65	83	101	161	252	B	38	37	45	45	55	C	13	13	13	13	13																		
DIM.	CASE DIAMETER																																																
	63	80	100	160	250																																												
A	65	83	101	161	252																																												
B	38	37	45	45	55																																												
C	13	13	13	13	13																																												
B TXCxxxXB		<table border="1" style="margin-left: auto; margin-right: auto;"> <thead> <tr> <th rowspan="2">DIM.</th> <th colspan="5">CASE DIAMETER</th> </tr> <tr> <th>63</th> <th>80</th> <th>100</th> <th>160</th> <th>250</th> </tr> </thead> <tbody> <tr> <td>A</td> <td>65</td> <td>83</td> <td>101</td> <td>161</td> <td>252</td> </tr> <tr> <td>B</td> <td>41</td> <td>40</td> <td>51</td> <td>51</td> <td>57</td> </tr> <tr> <td>C</td> <td>13</td> <td>13</td> <td>13</td> <td>13</td> <td>13</td> </tr> <tr> <td>D</td> <td>86</td> <td>110</td> <td>132</td> <td>196</td> <td>285</td> </tr> <tr> <td>H</td> <td>3.5</td> <td>4</td> <td>5.5</td> <td>6</td> <td>6</td> </tr> <tr> <td>P</td> <td>75</td> <td>95</td> <td>116</td> <td>178</td> <td>270</td> </tr> </tbody> </table>	DIM.	CASE DIAMETER					63	80	100	160	250	A	65	83	101	161	252	B	41	40	51	51	57	C	13	13	13	13	13	D	86	110	132	196	285	H	3.5	4	5.5	6	6	P	75	95	116	178	270
DIM.	CASE DIAMETER																																																
	63	80	100	160	250																																												
A	65	83	101	161	252																																												
B	41	40	51	51	57																																												
C	13	13	13	13	13																																												
D	86	110	132	196	285																																												
H	3.5	4	5.5	6	6																																												
P	75	95	116	178	270																																												
D TXCxxxXD		<table border="1" style="margin-left: auto; margin-right: auto;"> <thead> <tr> <th rowspan="2">DIM.</th> <th colspan="5">CASE DIAMETER</th> </tr> <tr> <th>63</th> <th>80</th> <th>100</th> <th>160</th> <th>250</th> </tr> </thead> <tbody> <tr> <td>A</td> <td>65</td> <td>83</td> <td>101</td> <td>161</td> <td>252</td> </tr> <tr> <td>B</td> <td>33</td> <td>29</td> <td>31</td> <td>32</td> <td>45</td> </tr> <tr> <td>C</td> <td>13</td> <td>13</td> <td>13</td> <td>13</td> <td>13</td> </tr> <tr> <td>D</td> <td>86</td> <td>110</td> <td>132</td> <td>196</td> <td>285</td> </tr> <tr> <td>H</td> <td>3.5</td> <td>4</td> <td>5.5</td> <td>6</td> <td>6</td> </tr> <tr> <td>P</td> <td>75</td> <td>95</td> <td>116</td> <td>178</td> <td>270</td> </tr> </tbody> </table>	DIM.	CASE DIAMETER					63	80	100	160	250	A	65	83	101	161	252	B	33	29	31	32	45	C	13	13	13	13	13	D	86	110	132	196	285	H	3.5	4	5.5	6	6	P	75	95	116	178	270
DIM.	CASE DIAMETER																																																
	63	80	100	160	250																																												
A	65	83	101	161	252																																												
B	33	29	31	32	45																																												
C	13	13	13	13	13																																												
D	86	110	132	196	285																																												
H	3.5	4	5.5	6	6																																												
P	75	95	116	178	270																																												
F TXCxxxXF		<table border="1" style="margin-left: auto; margin-right: auto;"> <thead> <tr> <th rowspan="2">DIM.</th> <th colspan="5">CASE DIAMETER</th> </tr> <tr> <th>63</th> <th>80</th> <th>100</th> <th>160</th> <th>250</th> </tr> </thead> <tbody> <tr> <td>A</td> <td>65</td> <td>83</td> <td>101</td> <td>161</td> <td>252</td> </tr> <tr> <td>B</td> <td>41</td> <td>40</td> <td>51</td> <td>51</td> <td>57</td> </tr> <tr> <td>D</td> <td>86</td> <td>110</td> <td>132</td> <td>196</td> <td>285</td> </tr> <tr> <td>H</td> <td>3.5</td> <td>4</td> <td>5.5</td> <td>6</td> <td>6</td> </tr> <tr> <td>P</td> <td>75</td> <td>95</td> <td>116</td> <td>178</td> <td>270</td> </tr> </tbody> </table>	DIM.	CASE DIAMETER					63	80	100	160	250	A	65	83	101	161	252	B	41	40	51	51	57	D	86	110	132	196	285	H	3.5	4	5.5	6	6	P	75	95	116	178	270						
DIM.	CASE DIAMETER																																																
	63	80	100	160	250																																												
A	65	83	101	161	252																																												
B	41	40	51	51	57																																												
D	86	110	132	196	285																																												
H	3.5	4	5.5	6	6																																												
P	75	95	116	178	270																																												
G TXCxxxXG		<table border="1" style="margin-left: auto; margin-right: auto;"> <thead> <tr> <th rowspan="2">DIM.</th> <th colspan="5">CASE DIAMETER</th> </tr> <tr> <th>63</th> <th>80</th> <th>100</th> <th>160</th> <th>250</th> </tr> </thead> <tbody> <tr> <td>A</td> <td>65</td> <td>83</td> <td>101</td> <td>161</td> <td>252</td> </tr> <tr> <td>B</td> <td>33</td> <td>29</td> <td>31</td> <td>32</td> <td>45</td> </tr> <tr> <td>D</td> <td>86</td> <td>110</td> <td>132</td> <td>196</td> <td>285</td> </tr> <tr> <td>H</td> <td>3.5</td> <td>4</td> <td>5.5</td> <td>6</td> <td>6</td> </tr> <tr> <td>P</td> <td>75</td> <td>95</td> <td>116</td> <td>178</td> <td>270</td> </tr> </tbody> </table>	DIM.	CASE DIAMETER					63	80	100	160	250	A	65	83	101	161	252	B	33	29	31	32	45	D	86	110	132	196	285	H	3.5	4	5.5	6	6	P	75	95	116	178	270						
DIM.	CASE DIAMETER																																																
	63	80	100	160	250																																												
A	65	83	101	161	252																																												
B	33	29	31	32	45																																												
D	86	110	132	196	285																																												
H	3.5	4	5.5	6	6																																												
P	75	95	116	178	270																																												

TYPE H AND I SEE PAGE 20

CAPILLARY DIAL THERMOMETERS

Type TXC, with stainless steel case according to EN 13190

STANDARD MODEL:

CASE	: bayonet lock, AISI304/1.4301, IP-65
CAPILLARY TUBE	: see page 24 (upto 100 meters)
STEM AND BULB	: AISI321/1.4541, see page 25, 27
CONNECTION	: AISI304/1.4301, see page 25 -27
WINDOW	: mineral glass 4 mm
DIAL	: aluminium, black figures on white
POINTER	: aluminium, black
RANGES	: from -200 upto +800°C, see page 28 - 30

EXAMPLE:

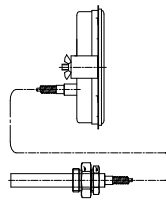

TXC160XH

ADJUSTMENT	: +/- 6 % F.S. with adj. screw at the side
OVERLOAD	: up to 30% F.S. (but max. 800°C)
ACCURACY	: ±1% F.S. / class 1
MOVEMENT	: brass
OPTIONS	: see page 32
CONTACTS	: see page 33 - 41,43
PT-100	: see page 42
TRANSMITTER	: see page 34,42

TYPE	MODEL	CASE DIAMETER (Ø in mm)				
		63	80	100	160	250
A 1140		TXC063XA	TXC080XA	TXC100XA	TXC160XA	TXC250XA
B 1142		TXC063XB	TXC080XB	TXC100XB	TXC160XB	TXC250XB
D 1141		TXC063XD	TXC080XD	TXC100XD	TXC160XD	TXC250XD
F 1148		TXC063XF	TXC080XF	TXC100XF	TXC160XF	TXC250XF
G 1145		TXC063XG	TXC080XG	TXC100XG	TXC160XG	TXC250XG
H 1146		TXC063XH	TXC080XH	TXC100XH	TXC160XH	TXC250XH
I -		TXC063XI	TXC080XI	TXC100XI	TXC160XI	TXC250XI
OPTION (see also page 32)		EXTRA COSTS				
Lx	LIQUID FILLED CASE: GLYCERINE (in combination with electrical device: Ondina oil, see page 43)	TXC063Lx	TXC080Lx	TXC100Lx	TXC160Lx	TXC250Lx

CAPILLARY DIAL THERMOMETERS TYPE TXC

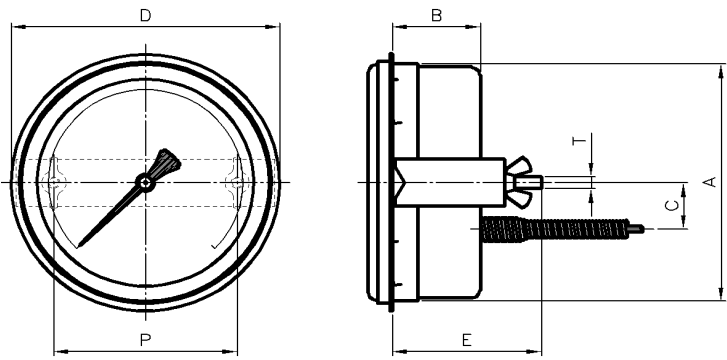
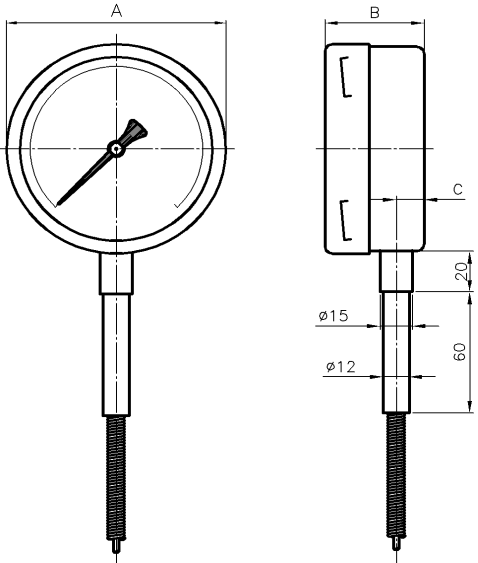
TYPE	DRAWING	DIMENSIONS mm																																																					
H TXCxxxXH		<table border="1"> <thead> <tr> <th rowspan="2">DIM.</th> <th colspan="5">CASE DIAMETER</th> </tr> <tr> <th>63*</th> <th>80</th> <th>100</th> <th>160</th> <th>250+</th> </tr> </thead> <tbody> <tr> <td>A</td> <td>65</td> <td>83</td> <td>101</td> <td>161</td> <td>252</td> </tr> <tr> <td>B</td> <td>30</td> <td>35</td> <td>35</td> <td>25</td> <td>45</td> </tr> <tr> <td>C</td> <td>20**</td> <td>25</td> <td>20</td> <td>20</td> <td>0</td> </tr> <tr> <td>D</td> <td>70</td> <td>85</td> <td>112</td> <td>180</td> <td>270</td> </tr> <tr> <td>E</td> <td>50</td> <td>55</td> <td>60</td> <td>60</td> <td>70</td> </tr> <tr> <td>P</td> <td>33</td> <td>59</td> <td>75</td> <td>139</td> <td>+</td> </tr> <tr> <td>T</td> <td>M5</td> <td>M5</td> <td>M5</td> <td>M5</td> <td>M5</td> </tr> </tbody> </table> <p>* U-clamp vertical mounted ** 20 mm to the left (front view) + with 3 clamps under 120 degr.</p>	DIM.	CASE DIAMETER					63*	80	100	160	250+	A	65	83	101	161	252	B	30	35	35	25	45	C	20**	25	20	20	0	D	70	85	112	180	270	E	50	55	60	60	70	P	33	59	75	139	+	T	M5	M5	M5	M5	M5
		DIM.		CASE DIAMETER																																																			
63*	80		100	160	250+																																																		
A	65	83	101	161	252																																																		
B	30	35	35	25	45																																																		
C	20**	25	20	20	0																																																		
D	70	85	112	180	270																																																		
E	50	55	60	60	70																																																		
P	33	59	75	139	+																																																		
T	M5	M5	M5	M5	M5																																																		
I TXCxxxXI		<table border="1"> <thead> <tr> <th rowspan="2">DIM.</th> <th colspan="5">CASE DIAMETER</th> </tr> <tr> <th>63</th> <th>80</th> <th>100</th> <th>160</th> <th>250</th> </tr> </thead> <tbody> <tr> <td>A</td> <td>65</td> <td>83</td> <td>101</td> <td>161</td> <td>252</td> </tr> <tr> <td>B</td> <td>38</td> <td>37</td> <td>45</td> <td>45</td> <td>55</td> </tr> <tr> <td>C</td> <td>13</td> <td>13</td> <td>13</td> <td>13</td> <td>13</td> </tr> </tbody> </table>	DIM.	CASE DIAMETER					63	80	100	160	250	A	65	83	101	161	252	B	38	37	45	45	55	C	13	13	13	13	13																								
		DIM.		CASE DIAMETER																																																			
63	80		100	160	250																																																		
A	65	83	101	161	252																																																		
B	38	37	45	45	55																																																		
C	13	13	13	13	13																																																		

CAPILLARY DIAL THERMOMETERS TYPE TPC

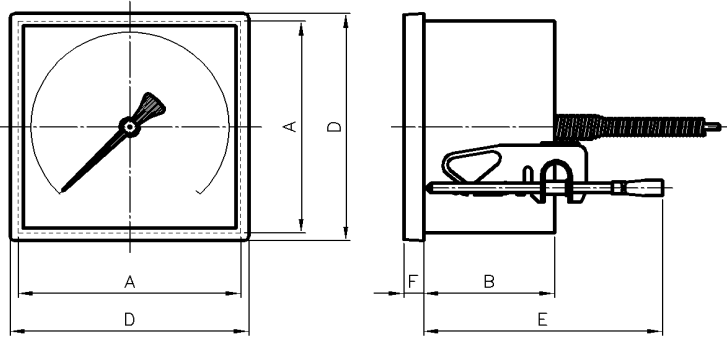
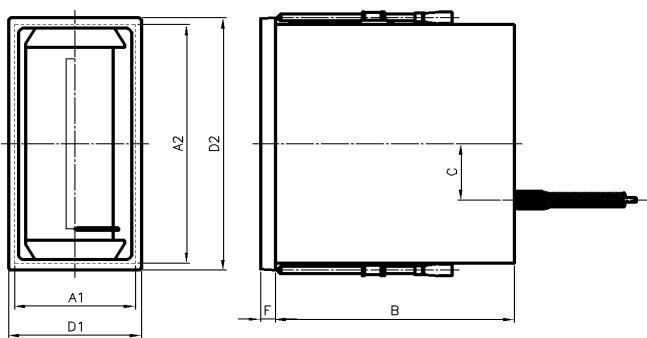
S TPCxxxxxXS		<table border="1"> <thead> <tr> <th rowspan="2">DIM.</th> <th colspan="4">CASE DIAMETER</th> </tr> <tr> <th>72 x 72</th> <th>96 x 96</th> <th>144x 144</th> <th>192x192</th> </tr> </thead> <tbody> <tr> <td>A</td> <td>66</td> <td>90</td> <td>136</td> <td>183</td> </tr> <tr> <td>B</td> <td>53</td> <td>53</td> <td>53</td> <td>89</td> </tr> <tr> <td>D</td> <td>72</td> <td>96</td> <td>144</td> <td>195</td> </tr> <tr> <td>E</td> <td>95</td> <td>95</td> <td>95</td> <td>95</td> </tr> <tr> <td>F</td> <td>8</td> <td>8</td> <td>8</td> <td>8</td> </tr> </tbody> </table>	DIM.	CASE DIAMETER				72 x 72	96 x 96	144x 144	192x192	A	66	90	136	183	B	53	53	53	89	D	72	96	144	195	E	95	95	95	95	F	8	8	8	8
		DIM.		CASE DIAMETER																																
72 x 72	96 x 96		144x 144	192x192																																
A	66	90	136	183																																
B	53	53	53	89																																
D	72	96	144	195																																
E	95	95	95	95																																
F	8	8	8	8																																
V/H TPCxxxxxXV TPCxxxxxXH		<table border="1"> <thead> <tr> <th rowspan="2">DIM.</th> <th colspan="2">CASE DIAMETER</th> </tr> <tr> <th>144x72</th> <th>192x96</th> </tr> </thead> <tbody> <tr> <td>A1</td> <td>66</td> <td>91</td> </tr> <tr> <td>A2</td> <td>136</td> <td>184</td> </tr> <tr> <td>B</td> <td>130</td> <td>155</td> </tr> <tr> <td>C</td> <td>30</td> <td>30</td> </tr> <tr> <td>D1</td> <td>72</td> <td>96</td> </tr> <tr> <td>D2</td> <td>144</td> <td>192</td> </tr> <tr> <td>F</td> <td>8</td> <td>8</td> </tr> </tbody> </table>	DIM.	CASE DIAMETER		144x72	192x96	A1	66	91	A2	136	184	B	130	155	C	30	30	D1	72	96	D2	144	192	F	8	8								
		DIM.		CASE DIAMETER																																
144x72	192x96																																			
A1	66	91																																		
A2	136	184																																		
B	130	155																																		
C	30	30																																		
D1	72	96																																		
D2	144	192																																		
F	8	8																																		

CAPILLARY

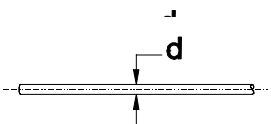
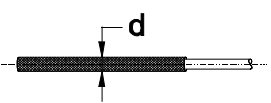
MATERIAL	MODEL	Ø d (mm)	Tmin	Tmax	CAPILLARY LENGTH Lc	
			°C		EXTRA COSTS	
STAINLESS STEEL AISI321 / 1.4541		2	-260	+800	per 1000 mm	
STAINLESS STEEL AISI321 / 1.4541 + PVC		4	-60	+120	per 1000 mm	

CAPILLARY COVERINGS for above mentioned capillary

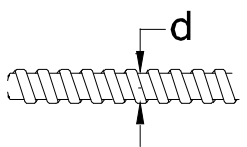
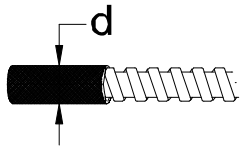
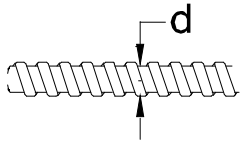
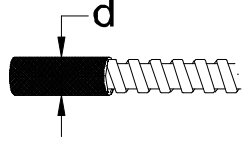
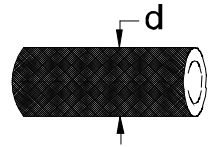
MATERIAL	MODEL	Ø d (mm)	Tmin	Tmax	CAPILLARY LENGTH Lc	
			°C		FIRST 1000 MM	FURTHER PER 1000 MM
FLEXIBLE STAINLESS STEEL AISI304/1.4301		7	-260	+800		
FLEXIBLE STAINLESS STEEL AISI304/1.4301 +PVC		8	-60	+120		
FLEXIBLE STAINLESS STEEL AISI316/1.4401		7	-260	+800		
FLEXIBLE STAINLESS STEEL AISI316/1.4401 +PVC		7	-60	+120		
PLUMB (Pb)		16	-20	+200		

BULB LENGTH AND DIAMETER FOR TYPE TXC

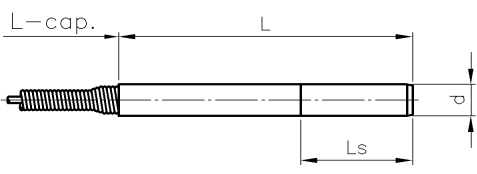
TYPE	STANDARD MODEL	bulb diameter Ø d	EXTRA COSTS per 100 mm STAINLESS STEEL AISI321/1.4541
A <i>plain stem</i>		9, 10, 12	per 100 mm
		6, 6.35, 8, 11, 12.5, 13, 14	per 100 mm
		7, 15, 16, 17, 18, 20	per 100 mm
FOR SHORTEST SENSITIVE PART "Ls": SEE PAGE 31		FOR OPTIONS ON BULB LENGTH AND DIAMETER: SEE PAGE 27	

CONNECTIONS FOR CAPILLARY MODELS TYPE TXC

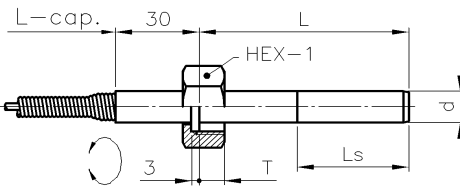
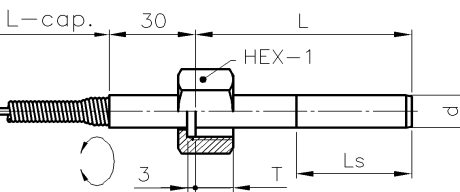
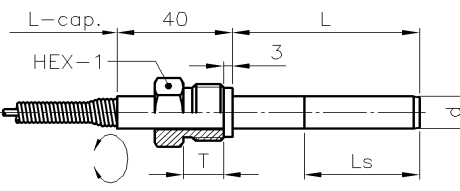
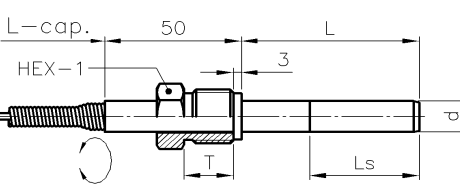
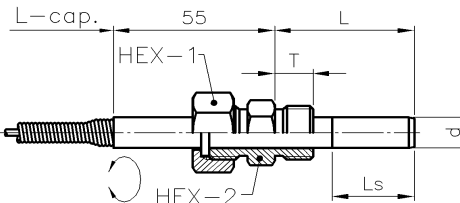
TYPE	MODEL	DIMENSIONS				EXTRA COSTS	
		connection	HEX-1	HEX-2	T	d max	STAINLESS STEEL AISI304/1.4301
B <i>coupling nut (standard model)</i>		1/4" BSP	22	-	7	Ø 8	
		3/8" BSP	27	-	9	Ø 11	
		1/2" BSP	27	-	9	Ø 15	
		3/4" BSP	32	-	9	Ø 20	
		1" BSP	41	-	13	Ø 20	
		M18x1.5	27	-	8	Ø 12	
		M20x1.5	27	-	9	Ø 14	
		M24x1.5	32	-	9	Ø 18	
BL <i>coupling nut (long model)</i>		1/2" BSP	27	-	14	Ø 15	
		3/4" BSP	32	-	16	Ø 20	
		1" BSP	41	-	18	Ø 20	
A04 <i>turning nipple (standard model)</i>		1/4" BSP	17	-	12	Ø 8	
		3/8" BSP	22	-	12	Ø 11	
		1/2" BSP	22	-	14	Ø 15	
		3/4" BSP	30	-	16	Ø 20	
		1" BSP	36	-	18	Ø 20	
		M18x1.5	22	-	12	Ø 12	
		M20x1.5	22	-	14	Ø 14	
M24x1.5	27	-	14	Ø 18			
AL04 <i>turning nipple (long model)</i>		1/2" BSP	22	-	20	Ø 15	
		3/4" BSP	30	-	20	Ø 20	
		1" BSP	36	-	25	Ø 20	
B 01 <i>coupling nut + double nipple</i>		1/4" BSP	27	22	12	Ø 8	
		3/8" BSP	27	22	12	Ø 11	
		1/2" BSP	27	22	14	Ø 15	
		3/4" BSP	27	27	16	Ø 20	
		1" BSP	27	36	18	Ø 20	
		1/4" NPT	27	22	14	Ø 8	
		1/2" NPT	27	22	20	Ø 15	
		3/4" NPT	27	27	20	Ø 20	
		1" NPT	27	36	25	Ø 20	
		M18x1.5	27	22	12	Ø 12	
		M20x1.5	27	22	14	Ø 14	
M24x1.5	27	27	14	Ø 18			
THREAD BETWEEN HEX-1 and HEX-2: 1/2" BSP							

CONNECTIONS FOR CAPILLARY MODELS TYPE TXC

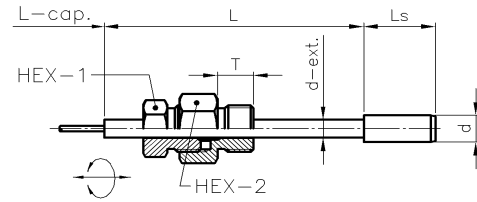
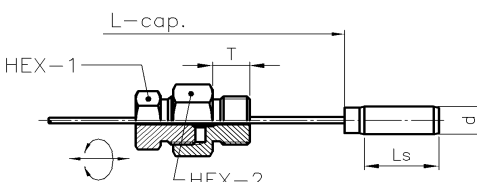
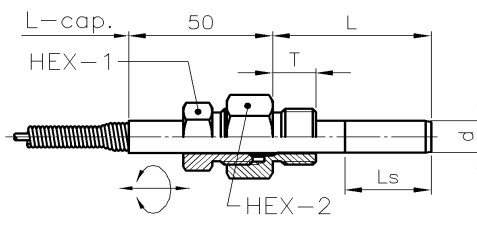
TYPE	MODEL	DIMENSIONS				EXTRA COSTS	
		connection	HEX-1	HEX-2	T	d max	STAINLESS STEEL AISI304/1.4301
		CS 1 <i>adjustable connection, sliding on extension tube</i>	 <p>THREAD BETWEEN HEX-1 and HEX-2: 1/2"BSP</p>	1/4"BSP	22	27	12
3/8"BSP	22			27	12	Ø 14	
1/2"BSP	22			27	14	Ø 18	
3/4"BSP	22			32	16	Ø 23	
1"BSP	22			36	18	Ø 30	
1/4"NPT	22			27	14	Ø 13	
1/2"NPT	22			27	20	Ø 20	
3/4"NPT	22			27	20	Ø 25	
1"NPT	22			36	25	Ø 32	
M18x1.5	22			27	12	Ø 16	
M20x1.5	22			27	14	Ø 18	
M24x1.5	22			27	14	Ø 22	
CS 2 <i>adjustable connection, sliding on capillary</i>	 <p>THREAD BETWEEN HEX-1 and HEX-2: 1/2"BSP</p>			1/4"BSP	22	27	12
		3/8"BSP	22	27	12	Ø 14	
		1/2"BSP	22	27	14	Ø 18	
		3/4"BSP	22	32	16	Ø 23	
		1"BSP	22	36	18	Ø 30	
		1/4"NPT	22	27	14	Ø 13	
		1/2"NPT	22	27	20	Ø 20	
		3/4"NPT	22	27	20	Ø 25	
		1"NPT	22	36	25	Ø 32	
		M18x1.5	22	27	12	Ø 16	
		M20x1.5	22	27	14	Ø 18	
		M24x1.5	22	27	14	Ø 22	
		CS 3 <i>adjustable connection, sliding on stem</i>	 <p>THREAD BETWEEN HEX-1 and HEX-2: 1/2"BSP</p>	1/4"BSP	22	27	12
3/8"BSP	22			27	12	Ø 11	
1/2"BSP	22			27	14	Ø 15	
3/4"BSP	22			32	16	Ø 20	
1"BSP	22			36	18	Ø 20	
1/4"NPT	22			27	14	Ø 8	
1/2"NPT	22			27	20	Ø 15	
3/4"NPT	22			27	20	Ø 20	
1"NPT	22			36	25	Ø 20	
M18x1.5	22			27	12	Ø 12	
M20x1.5	22			27	14	Ø 14	
M24x1.5	22			27	14	Ø 18	
	FOR CONNECTION TYPE CS3			1/2"BSP female			
		3/4"BSP female					
		1"BSP female					

